

**Model 142AH
Preamplifier
Operating and Service Manual**

Advanced Measurement Technology, Inc.

a/k/a/ ORTEC[®], a subsidiary of AMETEK[®], Inc.

WARRANTY

ORTEC* warrants that the items will be delivered free from defects in material or workmanship. ORTEC makes no other warranties, express or implied, and specifically NO WARRANTY OF MERCHANTABILITY OR FITNESS FOR A PARTICULAR PURPOSE.

ORTEC's exclusive liability is limited to repairing or replacing at ORTEC's option, items found by ORTEC to be defective in workmanship or materials within one year from the date of delivery. ORTEC's liability on any claim of any kind, including negligence, loss, or damages arising out of, connected with, or from the performance or breach thereof, or from the manufacture, sale, delivery, resale, repair, or use of any item or services covered by this agreement or purchase order, shall in no case exceed the price allocable to the item or service furnished or any part thereof that gives rise to the claim. In the event ORTEC fails to manufacture or deliver items called for in this agreement or purchase order, ORTEC's exclusive liability and buyer's exclusive remedy shall be release of the buyer from the obligation to pay the purchase price. In no event shall ORTEC be liable for special or consequential damages.

Quality Control

Before being approved for shipment, each ORTEC instrument must pass a stringent set of quality control tests designed to expose any flaws in materials or workmanship. Permanent records of these tests are maintained for use in warranty repair and as a source of statistical information for design improvements.

Repair Service

If it becomes necessary to return this instrument for repair, it is essential that Customer Services be contacted in advance of its return so that a Return Authorization Number can be assigned to the unit. Also, ORTEC must be informed, either in writing, by telephone [(865) 482-4411] or by facsimile transmission [(865) 483-2133], of the nature of the fault of the instrument being returned and of the model, serial, and revision ("Rev" on rear panel) numbers. Failure to do so may cause unnecessary delays in getting the unit repaired. The ORTEC standard procedure requires that instruments returned for repair pass the same quality control tests that are used for new-production instruments. Instruments that are returned should be packed so that they will withstand normal transit handling and must be shipped PREPAID via Air Parcel Post or United Parcel Service to the designated ORTEC repair center. The address label and the package should include the Return Authorization Number assigned. Instruments being returned that are damaged in transit due to inadequate packing will be repaired at the sender's expense, and it will be the sender's responsibility to make claim with the shipper. Instruments not in warranty should follow the same procedure and ORTEC will provide a quotation.

Damage in Transit

Shipments should be examined immediately upon receipt for evidence of external or concealed damage. The carrier making delivery should be notified immediately of any such damage, since the carrier is normally liable for damage in shipment. Packing materials, waybills, and other such documentation should be preserved in order to establish claims. After such notification to the carrier, please notify ORTEC of the circumstances so that assistance can be provided in making damage claims and in providing replacement equipment, if necessary.

Copyright © 2002, Advanced Measurement Technology, Inc. All rights reserved.

*ORTEC[®] is a registered trademark of Advanced Measurement Technology, Inc. All other trademarks used herein are the property of their respective owners.

CONTENTS

WARRANTY	ii
SAFETY INSTRUCTIONS AND SYMBOLS	iv
SAFETY WARNINGS AND CLEANING INSTRUCTIONS	v
1. DESCRIPTION	1
2. SPECIFICATIONS	2
2.1. PERFORMANCE	2
2.2. INPUTS	2
2.3. OUTPUTS	2
2.4. CONNECTORS	2
2.5. ELECTRICAL AND MECHANICAL	3
3. INSTALLATION	3
3.1. CONNECTION TO DETECTOR	3
3.2. ENERGY OUTPUT CONNECTION TO MAIN SHAPING AMPLIFIER	3
3.3. TIMING OUTPUT CONNECTION TO TIMING MODULES	3
3.4. INPUT OPERATING POWER	3
3.5. TEST PULSE	4
3.6. DETECTOR BIAS INPUT	4
3.7. CORONA ELIMINATION	4
4. OPERATION	5
4.1. GENERAL	5
4.2. DETECTOR BIAS	5
4.3. ENERGY OUTPUT	6
4.4. TIMING OUTPUT	6
4.5. COMPENSATION ADJUSTMENT	7
4.6. INPUT PROTECTION	8
5. MAINTENANCE INSTRUCTIONS	9
5.1. TESTING PERFORMANCE	9
5.2. CLEANING	10
5.3. FACTORY REPAIR	10

SAFETY INSTRUCTIONS AND SYMBOLS

This manual contains up to three levels of safety instructions that must be observed in order to avoid personal injury and/or damage to equipment or other property. These are:

- DANGER** Indicates a hazard that could result in death or serious bodily harm if the safety instruction is not observed.
- WARNING** Indicates a hazard that could result in bodily harm if the safety instruction is not observed.
- CAUTION** Indicates a hazard that could result in property damage if the safety instruction is not observed.

Please read all safety instructions carefully and make sure you understand them fully before attempting to use this product.

In addition, the following symbol may appear on the product:



ATTENTION—Refer to Manual

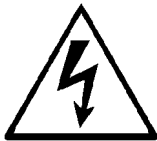

DANGER—High Voltage

Please read all safety instructions carefully and make sure you understand them fully before attempting to use this product.

SAFETY WARNINGS AND CLEANING INSTRUCTIONS

DANGER Opening the cover of this instrument is likely to expose dangerous voltages. Disconnect the instrument from all voltage sources while it is being opened.

WARNING Using this instrument in a manner not specified by the manufacturer may impair the protection provided by the instrument.

Cleaning Instructions

To clean the instrument exterior:

- Unplug the instrument from the ac power supply.
- Remove loose dust on the outside of the instrument with a lint-free cloth.
- Remove remaining dirt with a lint-free cloth dampened in a general-purpose detergent and water solution. Do not use abrasive cleaners.

CAUTION To prevent moisture inside of the instrument during external cleaning, use only enough liquid to dampen the cloth or applicator.

- Allow the instrument to dry completely before reconnecting it to the power source.



NOTICE

This preamplifier has been shipped to you with its protection circuit connected into the input circuit. The protection circuit prevents destruction of the input FET due to large transients under abnormal operating conditions and serves as an impedance matching termination for the input cable. The presence of the protection circuit imposes only a slight resolution degradation. With the protection circuit installed, the preamplifier is immune to almost anything the operator is likely to do that causes transients either at the detector input or at the bias input connector. It is very important that the protection circuit be installed when using bias voltages greater than 3 kV so that the input FET is protected from high-energy transients during possible momentary breakdown of the detector or the bias supply filtering circuitry.

The protection circuit does not protect the detector, but even if the detector breaks down as a result of over-voltage, the preamplifier will survive the resulting large transients if the protection circuit is in. This, of course, is not true if the protection circuit is out, in which case the input FET is very susceptible to destruction by transients at the detector input connector.

If the input protection circuit must be taken out for any reason, this involves disconnecting one transistor lead and installing a jumper across two series resistors. The Warranty on the 142AH is void if the protection circuit is taken out unless all of the following precautions are taken:

1. **COMPLETELY DISCHARGE** the detector bias circuit before connecting a low impedance, a cable, or any other capacitive device to the Detector Input connector on the preamplifier.

2. Discharge the detector bias circuitry before making **ANY** connections to the Detector Input connector and before disconnecting the preamplifier from the detector.

3. To discharge the detector bias circuitry, connect a low impedance (short cap preferably) across the Detector Bias connector on the preamplifier.

The input circuit will be destroyed if the Detector Input connector is shorted while the detector bias components are charged, and the quality of these capacitors is such that they will retain a charge through a long period of time. Such a short could result from connecting a detector, cable, or other capacitive device such as a voltmeter probe. A short circuit, either short term or continuous, will cause the applied bias voltage (stored on C34) to be coupled through C2 directly to the input transistor, causing a catastrophic breakdown.

If a variable supply is used, merely turning down the voltage control to zero and leaving it for at least one minute will suffice since the bias circuitry can discharge itself through the output of the bias supply.

Sometimes it is necessary to simply disconnect the bias supply, such as is the case when using batteries for bias. This situation leaves no discharge path, so a path must be provided by placing a short circuit or low impedance across the Detector Bias connector on the rear panel of the unit. **DO NOT SHORT the Detector Input connector** on the front panel of the instrument.

ORTEC MODEL 142AH PREAMPLIFIER

1. DESCRIPTION

The ORTEC 142AH Preamplifier is a charge-sensitive unit that is designed for use with room-temperature-operated silicon surface-barrier detectors. It has been designed to give the ultimate in both energy and timing resolution, with no compromise through either output circuit. The 142AH Preamplifier is compatible with detectors that have a capacitance in the range from 0 to 100 pF. It can operate with higher capacitances that are slightly degraded. The 142AH has a low-noise intercept and a moderate slope.

A differentiated timing output is directly compatible with most timing applications. The typical ORTEC modules that can use the timing signals from the 142AH include the 436 100-MHZ Discriminator, 454 Timing Filter Amplifier, 473A Constant-Fraction Discriminator, and 574 Timing Amplifier.

The energy range expected in typical applications is from 0 to 200 MeV. Two simultaneous outputs are provided; the output marked E is for energy measurements and the output marked T is for timing applications. Either or both outputs may be used as desired, since their circuits are isolated from each other. For best results, however, the T output should be terminated in 50Ω when not in use.

A bias circuit is included to accept the operating voltage required by the surface-barrier detector. The bias input circuit in the preamplifier includes a $100\text{-M}\Omega$ load resistor, and any detector leakage current will have to pass through this high resistance. A voltage drop is expected across this load resistor, proportional to the detector leakage, and this must be added to the bias value for the detector when adjusting the supply level.

An input protection circuit is built into the preamplifier circuits to protect the input FET from any large transient voltages that would otherwise damage the transistor. This is discussed in the Notice on page vi. The protection circuit also provides a damping resistance on the input so that relatively long cable lengths can be used between the detector and preamplifier without disrupting the system stability.

An internal rise time compensation adjustment is accessible through a hole in the case of the unit. See Section 4.5 for adjustment information.

If it is necessary to remove the cover for any reason, observe the following instructions carefully to prevent serious injury to yourself and/or damage to the instrument.

Observe the steps that are included in the Notice on page vi to discharge the high voltage to prevent shock; **the voltage levels that are used are lethal** and the capacitors are very high quality and retain a charge much longer than is normally expected.

Do not touch the high-megohm resistors, R4 and R7, with your bare fingers; the presence of skin oil can reduce the resistance of the component and alter operating characteristics.

See Section 4 for instructions that involve the protection circuit.

2. SPECIFICATIONS

2.1. PERFORMANCE

NOISE Based on silicon equivalent of $\epsilon = 3.6$ eV at $\tau = 2 \mu\text{s}$. (See Fig. 2.1.)

Detector Capacity (pF)	Typical Noise (keV)	Maximum Noise Guaranteed (KeV)
0	1.55	1.75
20	1.73	-
50	2.23	-
100	3.25	3.6

Typical intercept, 1.55 keV.

Typical slope, 17 eV/pF.

RISE TIME Based on a +0.5-V signal through the E output into a 93Ω circuit and measured from 10% to 90% of peak amplitude; rise time adjustment optimized; ≤ 5 ns at 0 pF, ≤ 12 ns at 100 pF.

CONVERSION GAIN Nominal, measured through the E output, 45 mV/MeV.

INTEGRAL NONLINEARITY Measured through the E output, $\leq 0.05\%$ for 0 to ± 7 V open circuit, or ± 3.5 V terminated.

TEMPERATURE INSTABILITY $< \pm 50$ ppm/ $^{\circ}\text{C}$, 0 to 50°C .

DETECTOR BIAS ISOLATION $\pm 5000\text{V}$.

OPEN LOOP GAIN $\geq 40,000$.

2.2. INPUTS

INPUT Accepts input signals from semiconductor charged-particle detector and extends operating bias to the detector.

BIAS Accepts the detector bias voltage from a power supply.

TEST Accepts input voltage pulses from a pulse generator for instrument and system calibration; $R_{in} = 93\Omega$.

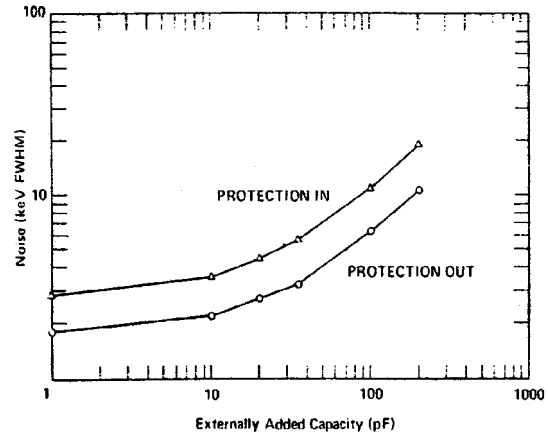

Fig. 2.1. 142AH Typical Noise (0.5 μs).

2.3. OUTPUTS

E Furnishes the output signals through $R_o = 93 \Omega$ for energy measurements; polarity is opposite from input pulse polarity (Fig. 2.4.).

T Furnishes a differentiated output signal compatible with typical 50Ω timing system requirements; polarity is the same as the input pulse polarity.

2.4. CONNECTORS

INPUT AND BIAS Type SHV.

TEST, E, AND T Type BNC.

POWER CABLE 10-ft (~3-m) captive power cable (ORTEC 121-C1); longer lengths available from ORTEC on special order.

2.5. ELECTRICAL AND MECHANICAL

POWER REQUIRED Furnished from any NIM bin and power supply through any ORTEC main amplifier or from an ORTEC 114 Power Supply; built-in captive cable is compatible with either source.

+24 V, 30 mA; -24 V, 10 mA;
+12 V, 15 mA; -12 V, 15 mA.

DIMENSIONS 1.75 X 5.2 X 4 in., plus 10-ft cable.
(4.45 X 13.2 X 10 cm, plus 3-m cable.)

3. INSTALLATION

3.1. CONNECTION TO DETECTOR

A direct connection with the shortest possible length of shielded cable should be made between the detector and the Input connector on the preamplifier. For best results, the length of this cable must be as short as possible to minimize the preamplifier noise (due to the capacitive loading of the cable) and to maintain the stability of the preamplifier. The complex impedance presented to the preamplifier input that is due to transmission line effects acting on the detector system impedance can disrupt the stability of the whole system. Due to vagaries in the detector system, a definite maximum length cannot be specified but is typically 60 inches (150 cm). Type RG-62/U cable is recommended for the detector to preamplifier connection; this is 72 Ω cable with a capacity of 21 pF/ft.

When operating at bias levels greater than 3 kV, special care must be taken to minimize spiking due to corona discharge from the type SHV connectors on the cable between the detector and the preamplifier. Normally, corona problems in the bias cable between the bias power supply and the preamplifier are significant due to the filtering circuit within the preamplifier.

After the input cable has been installed, the electronic noise performance of the preamplifier can be predicted by adding the capacity furnished by the detector to the capacity of the cable. The cable capacity can be calculated from its length and its rated capacity per foot.

3.2. ENERGY OUTPUT CONNECTION TO MAIN SHAPING AMPLIFIER

The E output of the preamplifier can be used to drive a long 93 Ω line to a shaping main amplifier and is designed to be directly compatible with ORTEC main amplifiers. It can be used with any shaping main amplifier if a power supply is also used to furnish the preamplifier power requirements that are available on all ORTEC main amplifiers.

3.3. TIMING OUTPUT CONNECTION TO TIMING MODULES

The T output of the preamplifier can be used to drive a long, terminated 50 Ω cable to a timing module. Typical timing modules include amplifiers, fast discriminators, or a time-to-amplitude converters. When the T output is not being used, it should be terminated in 50 Ω .

3.4. INPUT OPERATING POWER

Power for the 142AH Preamplifier is supplied through the captive power cord and 9-pin Amphenol connector. This connector can be attached to the mating power connector on any ORTEC main amplifier or 114 Preamplifier Power Supply. The preamplifier's power requirements are added to the operating power, requirements of the amplifier or power supply to which it is connected.

3.5. TEST PULSE

A voltage test pulse for energy calibration can be accepted through the Test input connector on the 142AH without the use of an external charge terminator. The Test input of the preamplifiers has an input impedance of 93Ω , and its circuitry provides charge injection to the preamplifier input. The shape of this pulse should be a fast rise time (less than 40 ns) followed by a slow exponential decay back to the baseline (200 to 400 μ s). While test pulses are being furnished to the Test input, connect either the detector (with bias applied) or its equivalent capacitance to the Input connector on the 142AH.

The Test input may be used in conjunction with a pulser such as the ORTEC 419 or 448 to calibrate the preamplifier E output amplitude in terms of energy or for multichannel analyzer calibration. However, due to stray coupling between the test circuit and other portions of the preamplifier circuitry, the transient performance of the preamplifier is best determined by connecting the actual detector signal through the Input connector instead of using the pulse generator signals.

A voltage test pulse for transient response in the 142AH can be accepted through a charge terminator and into the Detector Input connector. If external capacitance is to be included for these tests, an SHV tee can be inserted between the Input connector and the charge terminator, and this will then accommodate the test capacitances. Do not furnish any bias during these tests.

3.6. DETECTOR BIAS INPUT

Operating bias for the detector is supplied to the Bias connector on the 142AH and through a filter and large bias resistance to the Input signal connector. From there it is furnished out through the signal input cable to the detector.

Connect a cable from the detector bias supply (ORTEC 459 is typical) to the Bias connector on the 142AH. The connectors used in this high-voltage circuit are type SHV, and the mating cable should be furnished with the bias supply module

3.7. CORONA ELIMINATION

Because the normal range of bias voltages that are used for the detectors appropriate to the 142AH are extremely high, dust particles that settle within the Input connector tend to cause spiking when the high voltage is applied. The effect can be observed directly at the E output connector on the 142AH with no input signal. Figure 3.1 shows the typical output signal with large noise spikes due to a "dirty" Input connector. This can usually be eliminated, so that the output has an appearance like Fig. 3.2, by disconnecting the input cable (with the protection circuit installed) and blowing out the inner surfaces of the SHV connector with the "corona blower" that is furnished with the 142AH. In particularly stubborn cases, an orderly procedure must be used to determine the cause of spiking; a recommended procedure is as follows:

1. With no cable connected to the preamplifier Input, operate the preamplifier at the desired bias voltage while observing the E output, through a shaping amplifier, with an oscilloscope.
2. If spiking is present, blow out the Input connector with the blower several times until the spiking disappears.
3. Attach the input cable from the detector. If spiking appears, disconnect the cable and blow out the inner surfaces of the high-voltage connectors. Then attach the cable again and check for spiking.
4. Apply this procedure to the connectors of each individual cable section that has high-voltage connectors.
5. In laboratory areas that are particularly dusty, this procedure may have to be repeated several times to completely eliminate all traces of spiking.

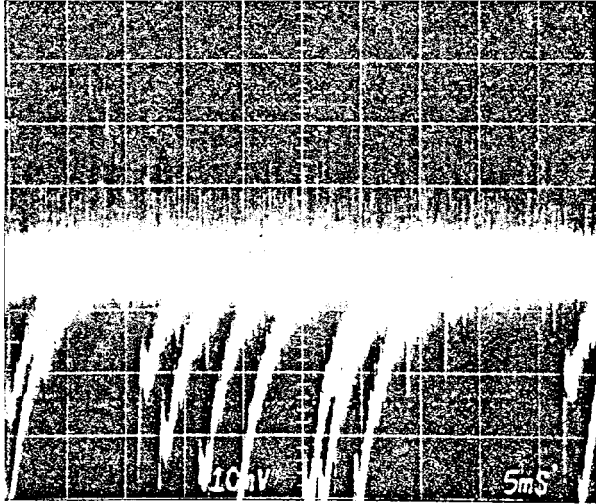

Fig. 3.1. Large Noise Spikes on E Output with No Signal Indicate Corona in the Detector Input Connector. Bias Voltage = +2500 V.

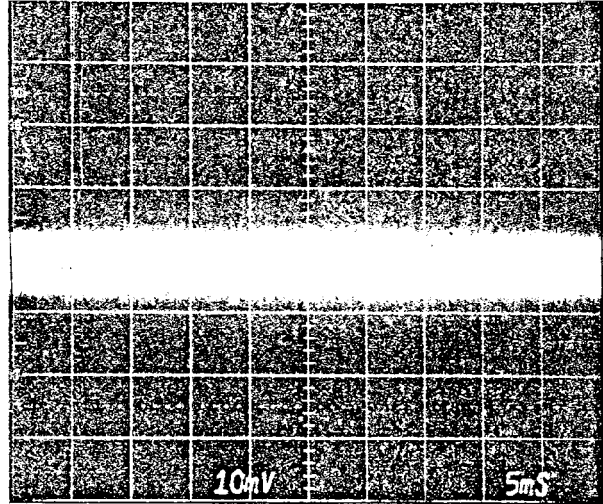

Fig. 3.2. Normal Noise on E Output with No Signal and No Corona. Bias Voltage = +5000 V.

4. OPERATION

4.1. GENERAL

Figure 4.1 is a simplified block diagram of the circuits in the 142AH Preamplifier. When the protection circuit is in, the diode between the two series input resistors to the amplifier stage is connected. When the protection circuit is out, the diode is disconnected and a jumper is used to short across the two series input resistors.

4.2. DETECTOR BIAS

The amount of bias required by the detector is specified in the data furnished with the detector. The bias accepted into the preamplifier through the SHV Bias connector is furnished through the load resistance (approximately 100 megohms) to the Input SHV connector of the preamplifier. If the detector leakage current is appreciable, a notable voltage drop will occur across the series load resistor in the preamplifier, and this must be added to the detector requirement when the bias supply level is adjusted.

When the detector bias must be raised to a level greater than 3000V, there are inherent problems associated with obtaining low noise and high performance. Careful design and good

manufacturing control, as well as extensive testing under full bias, assure that each preamplifier is free from spiking problems and that no degradation of noise performance will result when the required bias voltage is applied. But dust, dirt, and other surface contamination can collect within the Input connector and cause spiking problems due to corona discharge in the Input connector and associated cabling. This is especially true when the contamination occurs on the voltage-carrying center pin of the Input connector while the preamplifier is operating with bias voltages greater than 3000 V. These problems can usually be cured by directing a stream of clean compressed air or nitrogen into the end of the connector to blow off the surface contamination. This is a very subtle problem source because enough contamination can reaccumulate on the Input connector within several seconds after cleaning and cause recurrence of the corona. A dust cap is provided to keep the Input connector covered when it is not in use, and this will protect the interior surfaces when a cable is not connected. When the cable is connected, it can also transfer contaminants to the connector that can cause some spiking problems, even after the cable is removed.

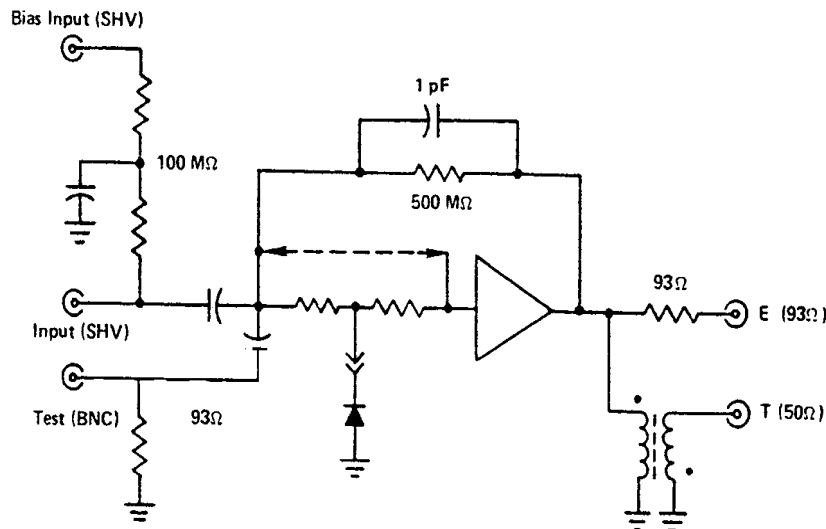

Fig. 4.1. Simplified Block Diagram of the ORTEC 142AH Preamplifier.

The corona blower that is furnished with the 142AH can be used to flush the interior connector surfaces with air when corona effects are observed. It can be used on both the Input connector on the preamplifier and on the connectors of the cables that are to be attached. It can also be used to clean the connectors at the detector end of the input cable. Simply insert the glass tube into the connector and squeeze the bulb to blow air into the connector.

With the protection circuit in, the input cable can be removed and reconnected without catastrophic damage to the preamplifier, but the user must be cautious to prevent touching the interior of the connector with anything other than a good insulator, such as the glass tube of the blower; lethal high voltages are present on the center pin of the Input connector under these conditions.

4.3. ENERGY OUTPUT

The charge-sensitive loop is essentially an operational amplifier with a 1-pF capacitive feedback. The conversion gain is nominally 45 mV/MeV, and can be increased by decreasing the value of the feedback capacity but a subsequent increase in rise time will result. The upper limit on the conversion gain is the stray capacity in the circuit with C4, the 1-pF capacitor, is removed

completely. The stray capacity is about 0.1 to 0.2 pF. If less conversion gain is desired, the value of the feedback capacity can be increased, but this may affect the stability of the preamplifier. The maximum recommended additional capacity is 1.5 pF.

The energy output signal from the preamplifier is a fast-rise-time voltage step with an exponential return to the baseline is about 500 μ s. The polarity of the E output signals is inverted from the signal polarity at the detector output. When the (normal) positive bias polarity is used for the detector, the detector output pulses are negative and the E output of the preamplifier is positive, as shown in Fig. 4.2.

4.4. TIMING OUTPUT

As indicated in Fig. 4.1, the T output from the preamplifier is a transformer differentiated and inverted version of the E output. This differentiation removes low-frequency noise for better timing results. Due to the differentiation of the charge loop output, any overshoot present will appear to increase the rise time of the timing output as shown in Fig. 4.3. This, however, does not affect typical timing experiment results since it is the initial slope of the waveform that carries the information of importance in timing. Similarly,

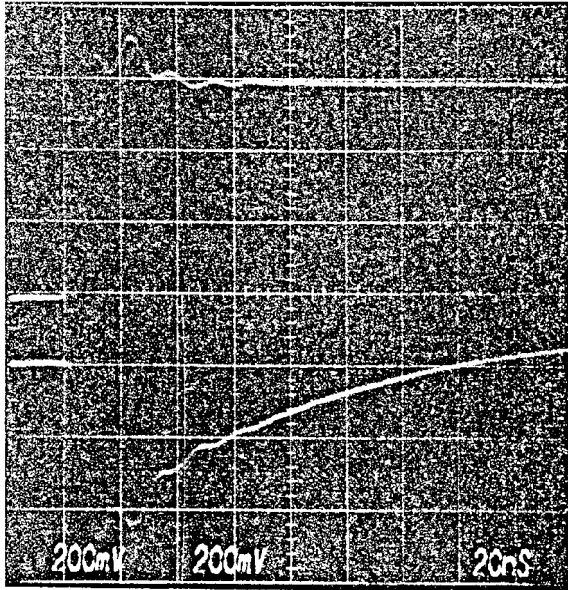

Fig. 4.2. Typical Simultaneous E and T Output Signals.

due to slewing effects and large signal bandwidth considerations within the charge loop, the large-signal rise time is slightly longer than that specified at the E output for an amplitude of 1.0V unterminated (0.5 V terminated). Again, however, this has no impact on a typical timing experiment since the slope of the leading edge is maintained over the whole dynamic range of the preamplifier, and since discriminator thresholds are typically set well below 1.0 V.

In Fig. 4.2, the rise time of the T output appears to be longer than that for the E output but this is not necessarily true. The 10% and 90% check points on the E rise time are based on the E_{final} level, which is less than the initial overshoot. On the other hand, the 10% and 90% check points on the T rise time are based on the peak level of the initial overshoot, which is relatively more than the final value for the E output.

4.5. COMPENSATION ADJUSTMENT

A bandwidth compensation adjustment is accessible to the user of the 142AH. This control can be adjusted through the bottom of the case without opening the unit. It is used to tune the preamplifier to the particular detector that is connected in order to provide the fastest optimal rise time of the T and E output signals for the best

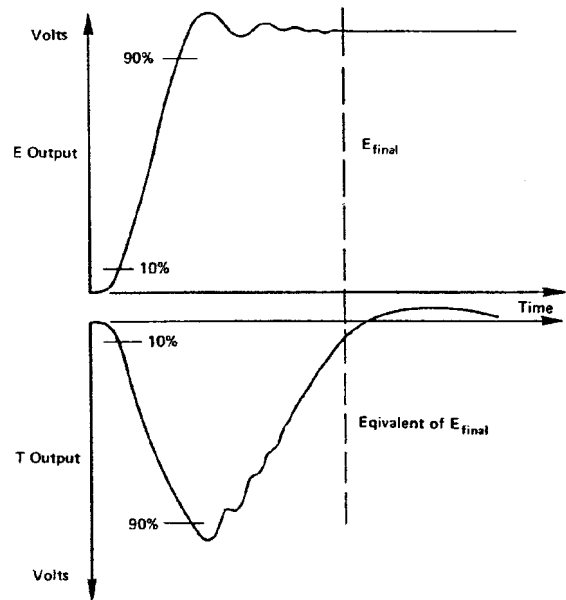

Fig. 4.3. Output Rise Time Measurement.

timing resolution when the rise time is optimized with this control. Because of the high voltages that are present inside the case when the preamplifier is operating, a small plastic screwdriver or a TV tuning tool should be used for this adjustment.

CAUTION

Do not use a metal screwdriver for this adjustment; there is a possibility of high-bias voltage leakage on the printed circuit that could cause a shock.

When the 142 AH Preamplifier is shipped from the factory, the compensation adjustment has been set for the specified rise time resolution for a 0-pF input capacity. For optimum results for other input capacities, the control should be adjusted under actual operating conditions.

If the control has been adjusted for optimum bandwidth for a specific input capacity and the input circuit is then changed to provide less capacity, control readjustment is necessary so that the preamplifier will not oscillate. If the input capacity is increased from the value for which the adjustment has been made, the preamplifier should be stable and should not oscillate.

4.6. INPUT PROTECTION

A provision is built into the preamplifier to protect the input FET stage from damage when high-voltage transients are applied to its input. These transients can result from any one or more of many causes, including detector breakdown, moisture condensation on the input connector, short circuits or uncharged capacitance connected across the input while bias is being applied through the preamplifier, or disconnection of a bias voltage without first reducing it gradually to zero.

The protection circuit is installed in the preamplifier when the unit is shipped from the factory. Although it offers protection to the FET, it also causes some degradation of the noise performance of the preamplifier, which increases as detector capacity increases.

With the protection circuit in, the collector lead of Q11 is attached to the center tap of the two series input resistors to the FET, R39 and R5. Transistor Q11 is connected as a diode, with both the base and the emitter tied through R8 to ground. This prevents the voltage in the input circuit from increasing beyond the safe limit for the FET input. To take the protection circuit out, simply remove the collector lead of Q11 from its circuit connection and install a wire jumper across R39 and R5.

Inherent to all high-speed charge-sensitive preamplifiers is the problem of keeping the total system stable while interconnecting the detector and preamplifier with long cables. To help ease this problem and permit more flexibility for installations, the protection circuit is designed to serve not only as a protection for the FET input but also to terminate the input cable in a nominal 100Ω. So it is recommended that the protection circuit be left in the preamplifier circuits whenever possible.

In order to take full advantage of the rise time capabilities of the 142AH for timing experiments (typical rise times of 4 to 10 ns for detector capacities of 1 to 100 pF), the total cable length should be kept as short as possible even though it is terminated. Due to vagaries in the scattering chamber system - ground loops, stray inductances, etc. - and since the maximum cable length is a factor in the input capacitance to the preamplifier, it is not possible to give absolute numbers. Generally, two feet is a typical maximum length to obtain fastest rise times for low-detector capacities. Of course, the system can be compensated for cable lengths of up to 5 or 6 feet but slower rise times will be obtained. The screwdriver adjustment inside the case can be used for this type of system. The rise times under these conditions will be in the range of 10 to 25 ns for capacitances from 1 to 100 pF. Typical results are shown in Fig. 4.4.

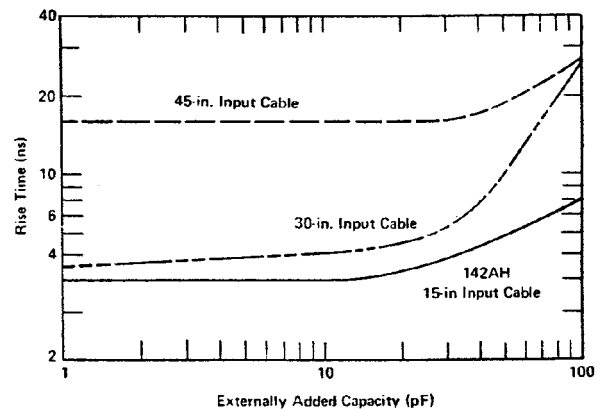

Fig. 4.4. 142AH Typical Rise Time.

5. MAINTENANCE INSTRUCTIONS

5.1. TESTING PERFORMANCE

As ordinarily used in a counting or spectroscopy system, the preamplifier is one part of a series system involving the source of particles to be analyzed, the detector, the preamplifier, the main amplifier, and the pulse height analyzer. When proper results are not being obtained and tests for proper performance of the preamplifier and the other components are indicated, it is important to realize that rapid and logical testing is possible only when the individual components are separated from the system. In proving the performance of the preamplifier, it should be removed from the system and be dealt with alone by providing a known electrical signal through the input and testing for the proper output signals with an oscilloscope as specified in steps 1 through 10.

1. Furnish a voltage pulse to the Test connector, as outlined in Section 3.5. The polarity of the test pulse signal should agree with the expected signal input polarity from a detector.

2. Using a calibrated pulser, the 142AH E output should be inverted from the input polarity and should have a nominal scale factor of 45 -mV output per 1-MeV equivalent energy (Si). The T output should have the same polarity as the inputs with a scale factor of about 20% less than the signals through the E output.

3. The noise contribution of the preamplifier may be verified by two basic methods. In either case, the normal capacity of the detector and associated cables should be replaced by a capacitor of equal value connected to the Input connector. This is necessary because the noise contribution of the preamplifier is dependent upon input capacity, as can be seen from the noise specifications given in Section 2. The only meaningful statement of the noise level of the preamplifier is one that relates to the spread caused by the noise in actual spectra. This can be measured and expressed in terms of the full width at half maximum (FWHM) of a monoenergetic signal after passing through the preamplifier and main amplifier system.

The noise performance referenced in Section 2 is stated in these terms, and verification methods will be described. If desired, the preamplifier can be tested with no external capacity on the Input connector, in which case the noise width should be approximately that shown for zero external capacity. In any case, the input connector and capacitors, when used, should be completely shielded electrically. A wrapping of aluminum foil around the Input connector or a shielding cap attached to the connector will suffice for testing at zero capacity.

4. The preamplifier must be tested in conjunction with an associated main amplifier that provides the required pulse shaping. The typical noise performance given in Section 2 is obtained using an ORTEC 472A Spectroscopy Amplifier on which the time constants have been set as specified. For comparison of these tabulated values, it is preferable to test the preamplifier under identical pulse-shaping conditions. It is also important to ensure that the noise level of the input stage of the associated main amplifier does not contribute materially to the total noise. This is usually no problem provided that input attenuators, if any, on the main amplifier are set for minimum attenuation.

5. If a multichannel analyzer is used following the main amplifier, testing of the noise performance can be accomplished by merely using a calibrated test pulse generator with charge terminator, as outlined in step 1. With only the charge terminator connected to the Input of the 142, the spread of the pulser peak thus analyzed will be due only to the noise contribution of the preamplifier and main amplifier. The analyzer can be calibrated in terms of keV per channel by observing two different pulser peaks of known energy, and the FWHM of a peak can be computed directly from the analyzer readout.

6. It is also possible to determine the noise performance of the preamplifier by the use of a wide-bandwidth rms ac voltmeter such as the Hewlett-Packard 3400A, reading the main amplifier output noise level and correlating with the expected pulse amplitudes per keV of signal under the same conditions. Again, a calibrated test pulse generator is required for an accurate measurement.

In this method the preamplifier and main amplifier are set up as they would be used normally, but with a dummy capacitor (or no capacity) on the Input connector of the 142AH, and with the ac voltmeter connected to the main amplifier output. The noise voltage indicated on the meter, designated E_{rms} , is read and noted. Then a test pulse of known energy, E_{in} (in keV), is applied to the Input and the amplitude of the resulting output pulse, E_{out} is measured in volts with an oscilloscope. The noise spread can then be calculated from the formula

$$FWHM \text{ (keV, Si det)} = \frac{2.35 (E_{rms}) (E_{in})}{E_{out}}$$

where E_{rms} is output noise in volts on the 3400A meter, E_{in} is input signal in keV particle energy, and E_{out} is output signal in volts corresponding to the above input. If the gain of the shaping amplifier is adjusted so that the output pulse height is 2.35 V for an input of 1 MeV equivalent charge, then the rms meter will be calibrated directly in energy (1 mV = 1 keV).

7. The noise performance of the preamplifier, as measured by these methods, should not differ significantly from that given in the specifications in Section 2.

8. If, during testing of the preamplifier and detector, the noise performance of the preamplifier has been verified as outlined in the preceding section or is otherwise not suspected, a detector may be tested to some extent by duplicating the noise performance tests with the detector connected in place and with normal operating bias applied. The resulting combined noise measurement, made either with an analyzer or by the voltmeter method, indicates the sum in quadrature of the separate noise sources of the amplifier and the detector. In other words, the total noise is given by

$$(N_{tot})^2 = (N_{det})^2 + (N_{amp})^2.$$

9. Each quantity is expressed in keV FWHM. The quantity N_{det} is known as the "noise width" of the detector, and is included as one of the specified parameters of each ORTEC semiconductor detector. By use of the above equation and with a knowledge of the noise of the preamplifier, the noise width of the detector can be determined.

The significance of this noise width in evaluating the detector is subject to interpretation, but generally the actual resolution of the detector for protons or electrons will be approximately the same as the noise width; the resolution of the detector for alpha particles will be poorer than the noise width. The most useful application of determining the noise width of a detector is in the occasional monitoring of this quantity to verify that the detector characteristics have not undergone any significant change during use.

10. Use an ORTEC 419 Precision Pulse Generator with a matched charge termination to measure the rise time of the 142AH through the T (timing) or E (energy) output. Connect the 419 output through the charge terminator to the Input on the 142AH and use an oscilloscope with a fast rise time (1 ns if possible). The rise time of the preamplifier can then be computed by:

$$\begin{aligned} (\text{Total rise time})^2 &= (\text{Preamp rise time})^2 \\ &+ (\text{Pulser rise time})^2 + (\text{Oscilloscope rise time})^2. \end{aligned}$$

The rise time of the 419 is typically 3 ns.

5.2. CLEANING

If it is necessary to clean the components and/or the printed circuit in the 142AH at any time, use only methanol as a cleaning solvent. Do not use compressed air or other source of pressurized gas unless it is known to be clean and free of compressor oil, and do not use any cleaning agent other than methanol.

5.3. FACTORY REPAIR

This instrument can be returned to ORTEC for service and repair at a nominal cost. Our standard procedure for repair ensures the same quality control and checkout that are used for a new instrument. Always contact the Customer Service Department at ORTEC, (865) 482-4411, before sending in an instrument for repair to obtain shipping instructions and so that the required Return Authorization Number can be assigned to the unit. Write this number on the address label and on the package to ensure prompt attention when it reaches the factory.